

## 1. S52 Incremental Optical Encoder (Solid shaft)

### 1.1 Introduction:

S52 is a solid shaft encoder with various electrical interfaces, with the highest protection grade IP65, compact and sturdy structure, and is widely used in industrial automation fields such as servo motors, textiles, CNC, packaging, elevators, etc.,

### 1.2 Feature:

- Encoder external diameter Ø51mm、thickness 29mm、 diameter of shaft Ø8mm;
- Adopt non-contact photoelectric principle;
- Reverse polarity protection;
- Short circuit protection;
- Multiple electrical interfaces available;
- Resolution per turn up to 48000PPR.

### 1.3 Application:

Servo motor, textile, CNC, packaging, elevator, industrial assembly line and other fields.

### 1.4 Connection:

- Radial cable (length 1M)
- Radial socket
- Radial cable with plug

### 1.5 Protection:

IP50 & IP65

### 1.6 Weight:

about 300g

S52-T

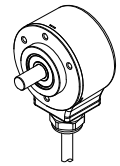

S52-C

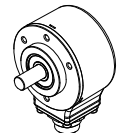

S52-TE

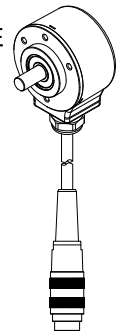

## 2. Model Selection Guide

### 2.1 Model composition(select parameters)

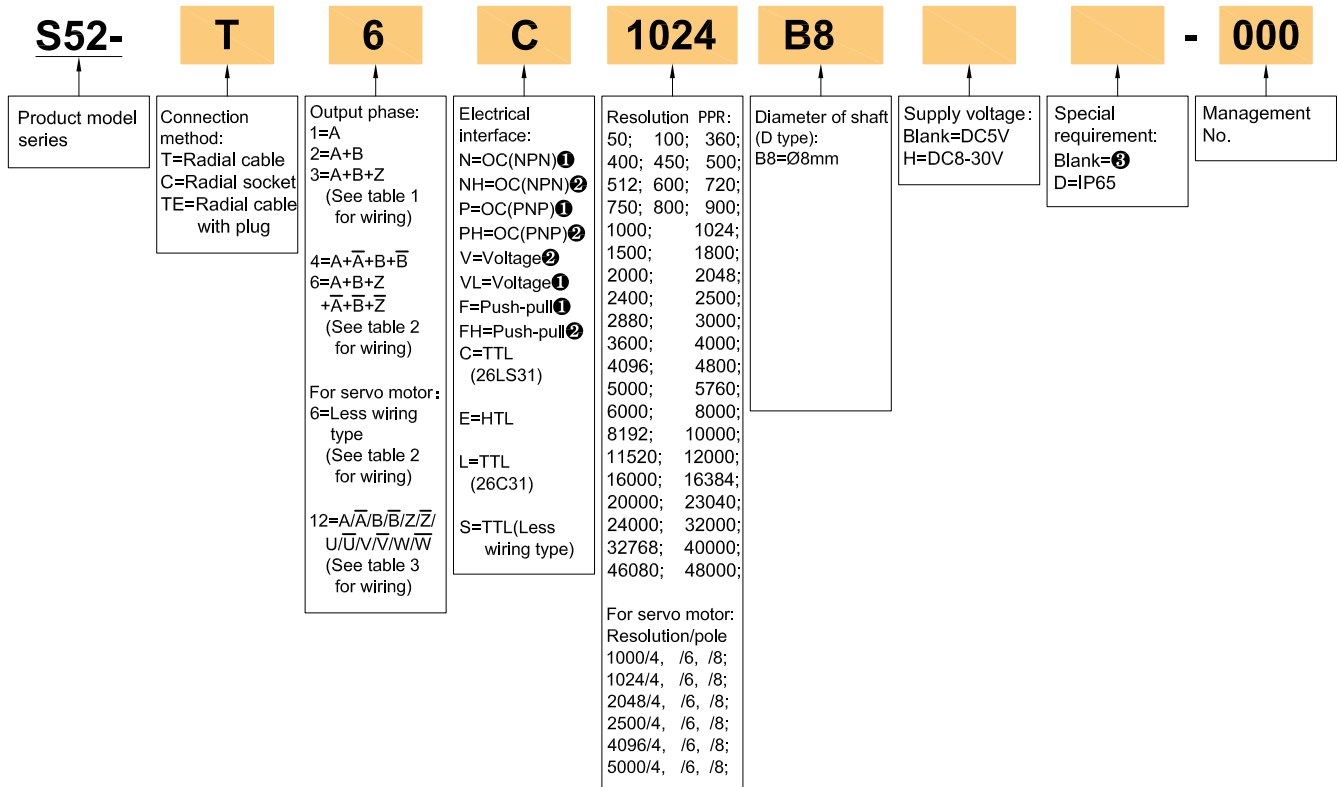

### 2.2 Note

- ①. Z signal is low level active.
- ②. Z signal is high level active.
- ③. None indicated for IP50 and cable length of 1M, if need to change the length C+number, the longest is 100M (expressed by C100). For the specific length of use, pls refer to page 2 of the provision of output circuit.

3. Output Mode

3.1 Incremental signal

Electrical interface	Output circuit	Output wave form
<p>OC NPN open collector circuit</p>		<p>a.b.c.d=<math>\frac{1}{4} \pm 8\%</math></p> <p>Phase A is ahead of B by <math>\frac{1}{4} \pm 8\%</math>, viewing from shaft end, direction is clockwise rotation. (See dimensional drawings)</p> <p>CW direction →</p> <p>Z signal is low level active</p>
<p>OC PNP open collector circuit</p>		
<p>Push-pull</p>		
<p>Voltage</p>		
<p>TTL (DC5V)</p> <p>HTL (DC8-30V)</p>		

**S52 INCREMENTAL**

3.2 For servo motor(with UVW)

Electrical interface	Output circuit	Output wave form																																																																	
<p>TTL (DC5V)</p>																																																																			
<p>TTL (DC5V) (Less wiring type)</p>	<div style="display: flex; justify-content: space-between;"> <div style="width: 45%;"> <p>26LS31, 26C31 Transmission distance 200m Max</p> <p><b>Symbol signification</b></p> <ul style="list-style-type: none"> <li>★: indicate position of UVW channel</li> <li>☆: position to start counting ABZ channel</li> <li>□: non-using zone</li> <li>HZ: high impedance</li> </ul> </div> <div style="width: 50%;"> <table border="1" style="width: 100%; border-collapse: collapse;"> <thead> <tr> <th rowspan="2">No.</th> <th rowspan="2">Color</th> <th colspan="3">Mode</th> </tr> <tr> <th>1</th> <th>2</th> <th>3</th> </tr> </thead> <tbody> <tr> <td>3</td> <td>white</td> <td>HZ</td> <td>U</td> <td>A</td> </tr> <tr> <td>4</td> <td>white/black</td> <td>HZ</td> <td><math>\bar{U}</math></td> <td><math>\bar{A}</math></td> </tr> <tr> <td>5</td> <td>green</td> <td>HZ</td> <td>V</td> <td>B</td> </tr> <tr> <td>6</td> <td>green/black</td> <td>HZ</td> <td><math>\bar{V}</math></td> <td><math>\bar{B}</math></td> </tr> <tr> <td>7</td> <td>yellow</td> <td>HZ</td> <td>W</td> <td>Z</td> </tr> <tr> <td>8</td> <td>yellow/black</td> <td>HZ</td> <td><math>\bar{W}</math></td> <td><math>\bar{Z}</math></td> </tr> <tr> <td>1</td> <td>red</td> <td colspan="3">DC+5V</td> </tr> <tr> <td>2</td> <td>black</td> <td colspan="3">OV</td> </tr> <tr> <td>0</td> <td>shielding</td> <td colspan="3">GND</td> </tr> </tbody> </table> </div> </div>	No.	Color	Mode			1	2	3	3	white	HZ	U	A	4	white/black	HZ	$\bar{U}$	$\bar{A}$	5	green	HZ	V	B	6	green/black	HZ	$\bar{V}$	$\bar{B}$	7	yellow	HZ	W	Z	8	yellow/black	HZ	$\bar{W}$	$\bar{Z}$	1	red	DC+5V			2	black	OV			0	shielding	GND			<p>Reverse signal not shown</p> <table border="1" style="width: 100%; border-collapse: collapse;"> <thead> <tr> <th>pole</th> <th>g.h.j.k.m.n</th> <th>r</th> </tr> </thead> <tbody> <tr> <td>4</td> <td><math>30 \pm 1^\circ</math></td> <td><math>180^\circ</math></td> </tr> <tr> <td>6</td> <td><math>20 \pm 1^\circ</math></td> <td><math>120^\circ</math></td> </tr> <tr> <td>8</td> <td><math>15 \pm 1^\circ</math></td> <td><math>90^\circ</math></td> </tr> </tbody> </table> <p><math>a.b.c.d = \frac{T}{4} \pm \frac{T}{8}</math>  <math>e = T \pm \frac{T}{2}</math>                      f: center of phase Z to rise point of phase U, that is <math>\pm 1^\circ</math></p> <p>CCW direction <math>\rightarrow</math></p> <p>Viewed from shaft end when installing. (See dimensional drawings)</p>	pole	g.h.j.k.m.n	r	4	$30 \pm 1^\circ$	$180^\circ$	6	$20 \pm 1^\circ$	$120^\circ$	8	$15 \pm 1^\circ$	$90^\circ$
No.	Color			Mode																																																															
		1	2	3																																																															
3	white	HZ	U	A																																																															
4	white/black	HZ	$\bar{U}$	$\bar{A}$																																																															
5	green	HZ	V	B																																																															
6	green/black	HZ	$\bar{V}$	$\bar{B}$																																																															
7	yellow	HZ	W	Z																																																															
8	yellow/black	HZ	$\bar{W}$	$\bar{Z}$																																																															
1	red	DC+5V																																																																	
2	black	OV																																																																	
0	shielding	GND																																																																	
pole	g.h.j.k.m.n	r																																																																	
4	$30 \pm 1^\circ$	$180^\circ$																																																																	
6	$20 \pm 1^\circ$	$120^\circ$																																																																	
8	$15 \pm 1^\circ$	$90^\circ$																																																																	
<p><b>Timing Chart</b></p>																																																																			

## 4. Electrical Parameters

Parameter Item	Output type	OC	Voltage	Push-pull	TTL	TTL (Less wiring type)	HTL
Supply voltage		DC+5V±5%; DC8V-30V±5%			DC+5V±5%		DC8-30V±5%
Consumption current		100mA Max			120mA Max		
Allowable ripple		≤3%rms					
Top response frequency		100KHz			300KHz		500KHz
Output capacity	Output current	Input	≤30mA	Load resistance 2.2K	≤30mA	≤±20mA	≤±50mA
		Output	—		≤10mA		
	Output voltage	"H"	—	—	≥ $\left[ \begin{array}{l} \text{(Supply voltage)} \\ -2.5V \end{array} \right]$	≥2.5V	≥V <sub>cc</sub> -3 V <sub>bc</sub>
		"L"	≤0.4V	≤0.7V(less than 20mA)	≤0.4V(30mA)	≤0.5V	≤1V V <sub>bc</sub>
Load voltage		≤DC30V	—		—		
Rise & Fall time		Less than 2us(cable length: 2m)			Less than 1us(Cable length: 2m)		≤100ns
Insulation strength		AC500V 60s					
Insulation resistance		10MΩ					
Mark to space ratio		45% to 55%					
Reverse polarity protection		✓					
Short-circuit protection		—			✓①		
Phase shift between A & B		90°±10° ( frequency in low speed)					
		90°±20° ( frequency in high speed)					
Delay motion time ②		—				510±220ms	—
GND		Not connect to encoder					

① Short-circuit to another channel or GND permitted for max 30s.

② Phase A.B.Z are back of phase U.V.W when power on.

## 5. Mechanical Specifications

Diameter of shaft	Ø8mm (D type)
Starting torque	Less than $5 \times 10^{-3} \text{N}\cdot\text{m}$
Inertia moment	Less than $3 \times 10^{-6} \text{kg}\cdot\text{m}^2$
Shaft load	Radial 50N; Axial 30N
Slew speed	$\leq 6000 \text{ rpm}$ ; IP65 $\leq 5000 \text{ rpm}$
Bearing Life	$1.5 \times 10^9$ revs at rated load(100000hrs at 2500RPM)
Shell	Aluminium alloy
Weight	about 300g

## 6. Environmental Parameters





Environmental temperature	Operating: $-20 \sim +85^\circ\text{C}$ (repeatable winding cable: $-10^\circ\text{C}$ ); Storage: $-20 \sim +90^\circ\text{C}$
Environmental humidity	Operating and storage: 35~85%RH(noncondensing)
Vibration(Endurance)	Amplitude 1.52mm,5~55Hz,2h for X,Y,Z direction individually
Shock(Endurance)	$490\text{m/s}^2$ 11ms three times for X,Y,Z direction individually
Protection	IP50 & IP65

7. Wiring Table

7.1 OC/Voltage/Push-pull (Table 1)









Socket pin definition (M16 8-pin male socket)	Supply voltage		Incremental signal					
	1	2	3	4	5	6	7	8
Wire color	Red	Black	White	Green	Yellow	-	-	-
Function	Up	0V	A	B	Z	-	-	-

7.2 TTL/HTL/Less wiring type (Table 2)

Socket pin definition (M16 8-pin male socket)	Supply voltage		Incremental signal					
	1	2	3	4	5	6	7	8
Wire color	Red	Black	White	White/BK	Green	Green/BK	Yellow	Yellow/BK
Function	Up	0V	A+ (U+)*	A- (U-)*	B+ (V+)*	B- (V-)*	Z+ (W+)*	Z- (W-)*
Twisted-paired cable								

\* For the functional status in less wiring mode, refer to the functional mode wiring table for output circuit on page3.

7.3 For servo motor (Table 3)

Socket pin definition (M16 14-pin male socket)	Supply voltage		Incremental signal											
	A	C	E	L	G	M	J	N	O	S	P	T	R	U
Wire color	Red	Black	White	White/BK	Green	Green/BK	Yellow	Yellow/BK	Blue	Blue/Bk	Grey	Grey/Bk	Pink	Pink/Bk
Function	Up	0V	A+	A-	B+	B-	Z+	Z-	U+	U-	V+	V-	W+	W-
Twisted-paired cable														

Up=Supply voltage.

Shield wire is not connected to the internal circuit of encoder.

Socket pin definition  
(M16 8-pin male socket)

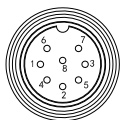

Socket pin definition  
(M16 14-pin male socket)

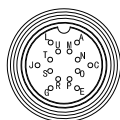

Cable connection

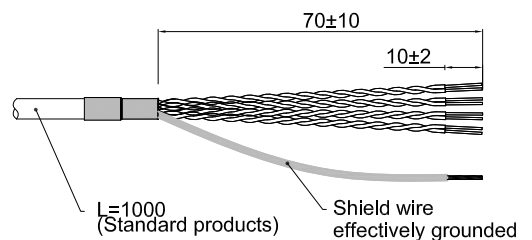

8. Basic Dimensions

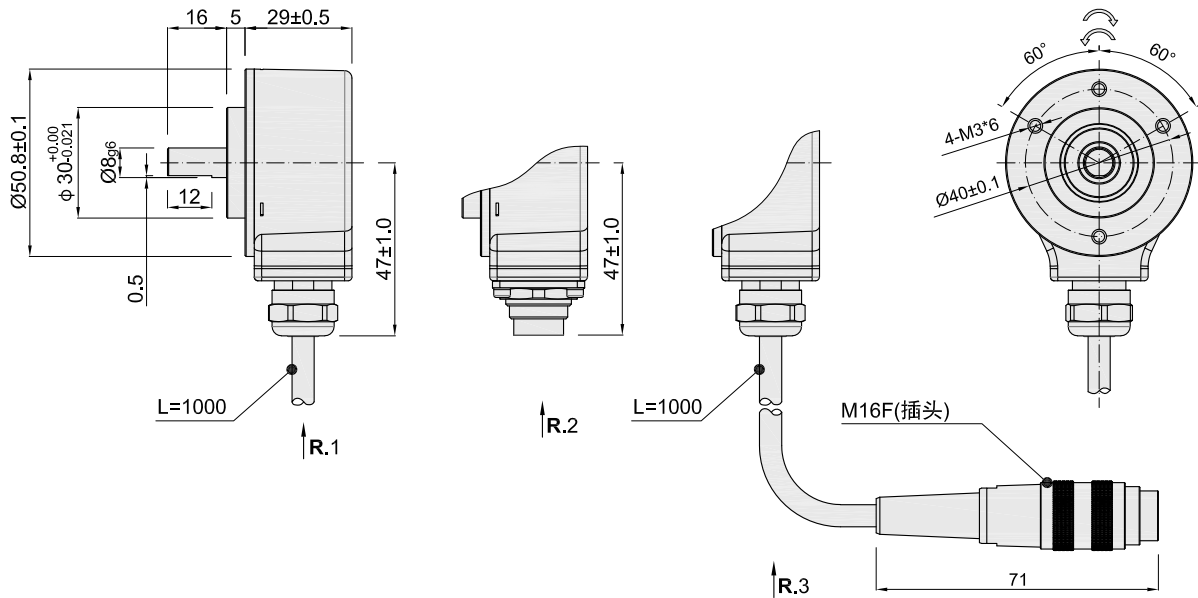

9. Mounting Shaft Requirements



Notice : The radial runout of motor shaft should be less than 0.03mm, and the angle should be less than 1.0°.

Unit: mm

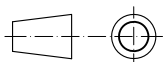

- = Direction of shaft rotation for incremental signal output
- = Direction of shaft rotation for servo motor-specific signal output

- R.1 = Radial cable
- R.2 = Radial socket
- R.3 = Radial cable with plug

## 10. Caution

### 10.1 About vibration

Vibration act on encoder always cause wrong pulse, so we should pay attention to working place. More pulse per revolution, narrower groovy spacing of grating, more effect to encoder by vibration, when rev is low or stop, vibration act on shaft or main body would cause grating vibrating, so encoder might make wrong pulse.

### 10.2 Caution for wiring

- Use the encoder under the specified supply voltage. Please note that the supply voltage range may drop due to the wiring length.
- Do not put the encoder wiring and other power lines through the same duct, and do not use them by bundling in parallel.
- Please use twisted pair wires for the signal and power wires of encoder.
- Please do not apply excessive force to the cable of encoder, or it will may be damaged.

